

14-5-2018



WESSELING BV

Quality since 1958

New Plaster Master

A must have for every Hospital

USER'S MANUAL AND MAINTENANCE GUIDE



CE

CONTENTS

1. GENERAL INFORMATION	2
MANUFACTURER	2
EQUIPMENT INTENDED USE AND DESCRIPTION	2
STORAGE	2
SYMBOLS	2
2. SPECIAL WARNINGS AND USE RESTRICTIONS	3
3. USE	3
STARTING UP	3
SETTING UP AND ADJUSTMENTS	3
TRANSPORTATION AND BRAKES	5
FITTING AND USING THE ACCESSORIES-OPTIONAL EXTRAS:.....	6
4. CLEANING and CONSERVATION	10
5. MAINTENANCE	10
SPARE PARTS:	10
6. TROUBLESHOOTING	11
7. TECHNICAL DATA SHEET	11
8. WARRANTY	12
9. SERVICE RECORD	12

1. GENERAL INFORMATION

MANUFACTURER

Wesseling BV, Venenweg 31, 1161 AK Zwanenburg, Netherlands-Tel.+31 204975183-Fax+31 204975909 – website:www.wesseling-bv.com

EQUIPMENT INTENDED USE AND DESCRIPTION

The New Plaster Master table is intended for examining and treating patients. With the additional options this table can be used for every plaster technique. The entire frame is epoxy powder coated and the top is upholstered and covered in fireproof synthetic leather. It's equipped with an electric backrest, electric upper-body section and electric height adjustment. All are adjustable by means of a triple foot control. Upper leg section as well as lower leg section can be inclined with the help of gas springs. The gas springs are all adjusted by handles that are easy to access on both sides of the table. The brakes and lock are centrally controlled by means of a foot pedal that is easy to activate.



STORAGE

When storing, the following conditions must be met:



1. relative humidity 10% / 90 % - temperature -10°C / +50°C

SYMBOLS

The various symbols appearing in this manual and on the equipment itself are meant to draw the user's attention on important safety warnings and useful information. Please observe all warning, caution and hazard notices.

	<p>WARNING Warning messages are used to advise users/patients about any risk of injury or danger if the specified procedures and conditions are not carefully observed during operation or maintenance activities.</p>
	<p>CAUTION Caution symbols are used to advise users about an operation or maintenance procedure, best practice or condition that may damage the equipment if not duly complied with.</p>

2. SPECIAL WARNINGS AND USE RESTRICTIONS

	<p>Equipment must not be used:</p> <ul style="list-style-type: none"> • Without knowing the user's manual. • When the safety load exceeds the stated capacity. • Without the patient being monitored. • When the patient and/or equipment is not stable enough. • When table is not on its feet when stopped, during treatment, or when patient is moved to/from other equipment. • When the original product has been tampered with and/or modified from its original configuration. • When the controls and/or components are even only partially faulty or defective. • When incorrectly configured or when you think it may cause damage to a patient or user. • Do not allow any body parts to enter the areas with moving components and/or controls.
	<ul style="list-style-type: none"> • Foam rubber and plastic components may burn if they come in contact with naked flames. • Corrosive and/or abrasive detergents may damage the covers and paintwork. • The equipment is not suitable for use outdoors and/or in surfaces that are not smooth enough.
!!!!!!!!!!!! NEVER LEAVE THE TABLE UNATTENDED WHEN THERE IS A PATIENT ON IT !!!!!!!!!!!!!	







3. USE

STARTING UP

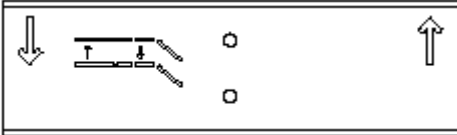

For packaging reasons the couch is supplied covered by protective means that are to be removed, avoiding direct contact with cutters that could damage it. Any damage in transit must be reported to the transporter and seller immediately, without using the equipment for safety reasons.

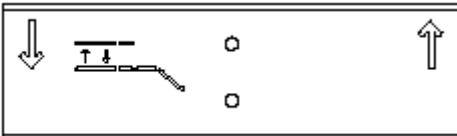
SETTING UP AND ADJUSTMENTS

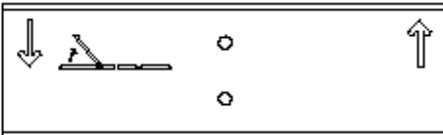
The table has electric actuators for the complete table, for the upper body section, and for the back section. The leg sections are all individually fitted with gas springs.

ADJUSTMENT/FUNCTION	CONTROL	PROCEDURE
		At both sides of the table is a triple foot-switch.
		Push the relevant symbol to adjust the height of the entire table. Use the switch which is closest to the lower leg-rests.
		Push the relevant symbol to adjust the height of the upper body-frame. Use the center switch.
		Push the relevant symbol to adjust the angle of the backrest. Use the switch which is closest to the backrest.

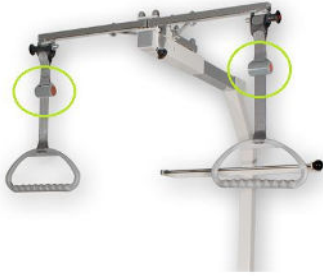

ADJUSTMENT/FUNCTION	CONTROL	PROCEDURE
		<p>To adjust the lower leg sections pull the control handle, and support the section as it moves. Release the handle to secure the position.</p> <div style="border: 1px solid black; padding: 5px; text-align: center;">  WARNING  </div> <ul style="list-style-type: none"> Do not sit on the lower leg section
		<p>To adjust the upper leg sections pull the control handle, and support the section as it moves. Release the handle to secure the position.</p>
		<p>To create room for applying a plastercorset or a “Durchhangcorset “ when laying prone, the pelvic support can be removed:</p> <ul style="list-style-type: none"> First put the upper body-frame into its highest position by pushing the relevant symbol on the triple foot-switch. Release the black handscrew at the left side of the backrest. Pull out the lockpin which is located at the right side of the backrest. <p>Now the sit-cushion with its supporting frame can be removed. To put back the pelvic support again, please take the same steps in reverse order.</p> <div style="border: 1px solid black; padding: 5px; text-align: center;">  WARNING  </div> <ul style="list-style-type: none"> Only adjust the height of the upper body-frame when the pelvic support is completely pushed in or removed. Therefore, always pay attention that the black lockpin is retracted and the black handscrew completely tightened.
		<p>The horizontal part of the monkey pole is adjustable in length and width. As it is mounted on the frame it will go up or down simultaneously. Therefore the distance between the upholstery and the handgrips will not change during the adjustment of the height.</p> <ul style="list-style-type: none"> To adjust the length: Release the black hand screw at the bottom side and the tube can be adjusted alongside the chrome bar. Tighten the hand screw again when the bar has reached its required position. To adjust the width: release the black hand screw at the top side. Now the 2 chrome bars can be moved for- or backwards. Tighten the hand screw when the required width has been reached.
		<ul style="list-style-type: none"> Both handgrips can be removed by pushing the red button of the lockpin and pull them backwards.

		<ul style="list-style-type: none"> The straps of the handgrips roll up automatically by pushing the red buttons.
		<p>The table has full length fixation rails (25x10mm) on both sides as a standard feature. On these rails one can slide several types of rail clamps (optional).</p>

TRANSPORTATION AND BRAKES

The table has four swivel wheels to allow movements in tight spaces. At the back-side of the table is the stirrup bar of the wheel-lift system. By pushing this stirrup bar downwards the table becomes mobile. Lift the stirrup bar upwards again after reaching the required position so the castors will be retracted. The system uses a gas spring as shock-absorber. Never use the table if the castors are not fully retracted! The 4 feet have an anti-slip surface and can be adjusted individually when the floor is not even.









MOVING THE TABLE	PUT THE TABLE ON ITS FEET	PROCEDURE
		<ul style="list-style-type: none"> To move the table use the foot to push down the bar till it stops. To put the table on its feet use the foot to push up the bar until all the feet are on the floor.





WARNING





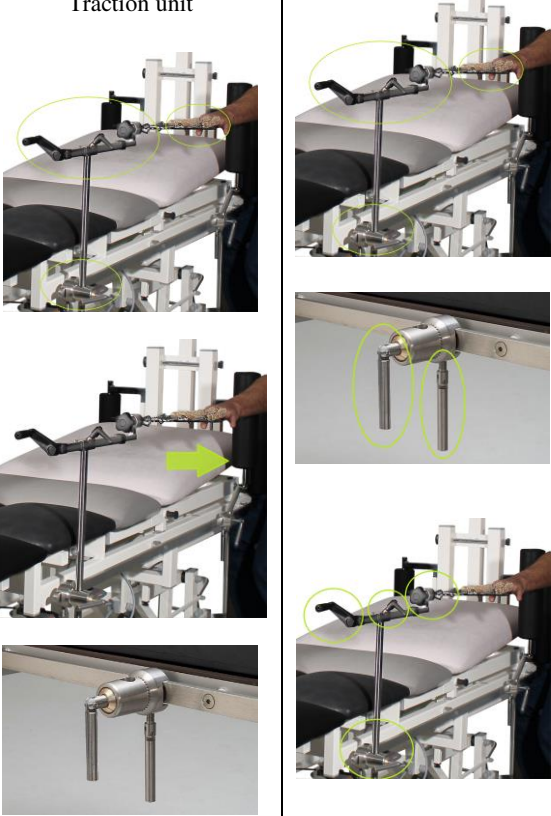

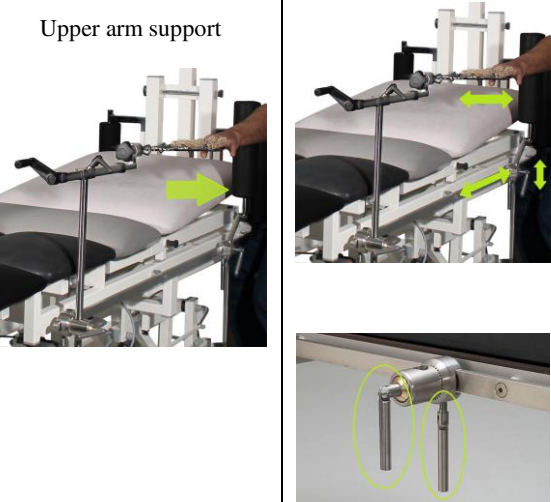
- Putting the table on its feet is essential when transferring and treating the patient.



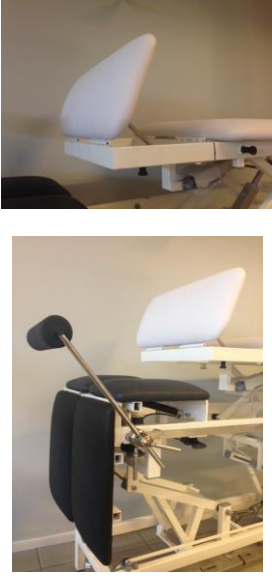
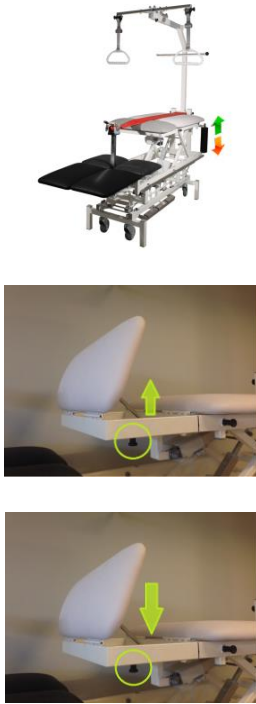

FITTING AND USING THE ACCESSORIES-OPTIONAL EXTRAS:

The table's use can be extended by means of the accessories - optional extras

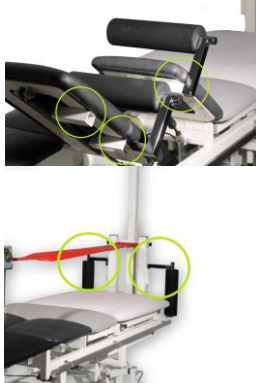
ACCESSORY – OPTIONAL EXTRA	CONTROL	PROCEDURE
<p>Pelvic support for children</p> 		<ul style="list-style-type: none"> • First put the upper body-frame in its highest position by pushing the relevant symbol on the triple foot-switch. Level this section with the adapter for the pelvic support. • To push in the Lexan pelvic support: pull the knob with on hand and slide in the support. • To remove the Lexan pelvic support: pull the knob with on hand and pull out the support. <div style="border: 1px solid black; padding: 5px; text-align: center;">  WARNING  </div> <ul style="list-style-type: none"> • Make sure that there is no weight on the pelvic support when you try to remove it. • Do not exceed the maximum weight of 25kg on the Lexan pelvic support.
<p>Corset strap and spanner</p> 		<p>The optional corset strap can be installed to apply a plaster corset while the patient is lying in horizontal position.</p> <ul style="list-style-type: none"> • The upper body-frame is in its lowest position. Pull out the massive pin which goes through the two vertical tubes of the monkey pole. Take the wide side of the strap. Hold the loop between the vertical tubes of the monkey pole and push the massive pin through the loop and the tubes. Lock the pin on the outside. • Insert the belt spanner into the relevant tube between the upper leg-rests. This is the tube closest to the hinges of the lower leg-rests. Tighten the black hand screw at the front of the tube. When standing at the front of the table, the nut of the belt spanner should be on your left. <ul style="list-style-type: none"> • Now the patient can lie down and should grab the handgrips. Both lower leg-rests can be put in their most upright position to give best possible stability. <ul style="list-style-type: none"> • Now put the upper body-frame into its highest position. Insert the corset strap into the spanner and adjust the tension with the wrench. Put the safety pin in place! The upper body-frame can now be lowered to create enough room for applying the plaster corset. Remove the wrench before treatment. • After finishing the corset one can put the upper body-frame into its highest position again. Remove the safety pin and increase the tension on the strap slightly with the wrench, while at the same time pushing down the locking handle on the right side. Hold the wrench during this movement to prevent it from spinning around. Remove the strap from the belt spanner and pull the strap out from the patient so it is no longer in touch with its body. Now the upper body-frame can be put in its lowest position again. <div style="border: 1px solid black; padding: 5px; text-align: center;">  WARNING  </div> <ul style="list-style-type: none"> • Watch carefully when raising and lowering the upper body-frame. Ensure that neither the patient nor you can get any part of the body between this moving section.



<p>Traction unit</p> 	<p>The traction unit can be used for finger, wrist and under-arm traction. The following options are needed in order to use the traction-unit correctly:</p> <ul style="list-style-type: none"> • Traction unit • Radial clamp (2x) • Frame for Chinese fingers • Chinese fingers • Upper arm support <p>The traction unit can be adjusted in height, width, length and angle using the clamp and the system itself.</p> <ul style="list-style-type: none"> • To adjust the width: Loosen the clamp with the lever in the middle and twist the unit to the desired position. Now tighten the clamp to keep the traction system in place. • To adjust the height: Loosen the clamp with the lever in the middle and put the system at the desired height. Now tighten the clamp to keep it in place. • To adjust the angle with the clamp: loosen the lever in the middle and adjust the angle. When the traction system is placed in the right position, tighten the clamp again with the same lever. • To adjust the angle with the system itself: at the front of the system is a black hand screw. Loosen this screw and adjust the angle of the Chinese fingers. Tighten the screw when it is in place. • To adjust the “length” with the clamp: to put the traction unit in the right position for the patient one can slide it over the rails using the clamp. Loosen the lower lever to loosen the clamp from the rail. Now slide it over the rail to the desired position and tighten it again. • To adjust the “length” with the system itself: in the middle of the unit is a black lever. Loosen this lever to adjust the length of the traction unit in small steps. When the unit is in the right position tighten the lever again. <p>To use the traction system turn the lever on the back of the traction system. This lever is very easy to turn and the system is very slow and sensitive.</p>
<p>Radial clamp</p> 	<p>The radial clamp is necessary in order to use a number of accessories. These rail clamps fit on the rail that is mounted standard on the table.</p> <ul style="list-style-type: none"> • To mount the clamp to the rail: hook it in a downward movement. Now tighten the clamp with the lower lever. • To fix any accessory: Put the accessory in the clamp (max diameter 20mm) and tighten the clamp with the lever in the middle. • To adjust the angle of an accessory: Loosen the lever in the middle and adjust the angle. When the accessory is placed in the right position, tighten the clamp again with the same lever.
<p>Upper arm support</p> 	<p>The upper arm support is used to keep the arm of the patient in place, for instance during traction. This support can only be used in combination with the radial clamp.</p> <ul style="list-style-type: none"> • To mount the clamp to the rail: hook it in a downward movement. Now tighten the clamp with the lower lever. • To fix the arm support: Put the support in the clamp and tighten the clamp with the lever in the middle. <p>The upper arm support can be adjusted in height, width, length and angle.</p> <ul style="list-style-type: none"> • To adjust the width: the support can be adjusted in width because of the bended steel frame. Loosen the clamp with the lever in the middle and twist the support to the desired position. Now tighten the clamp to keep the support in place. • To adjust the height: Loosen the clamp with the lever in the middle and put the support at the desired height. Now tighten the clamp to keep the support in place. • To adjust the “length”: to put the support in the right position for the patient one can slide it over the rails using the clamp. Loosen the lower lever to loosen the clamp from the rail. Now slide it over the rail to the desired position and tighten it again. • To adjust the angle: Loosen the lever in the middle and adjust the angle. When the support is placed in the right position, tighten the clamp again with the same lever.

<p>Foldable sitting section</p> 		<p>The sitting section can be folded so it becomes a backrest. This can be very useful to create a chair on the front of the table. In combination with the knee support this is ideal for plaster the hanging leg.</p> <ul style="list-style-type: none"> • First put the upper body-frame in its highest position by pushing the relevant symbol on the triple foot-switch. • Pull out the lock pin which is located at the right side of the sitting section and at the same time pull up the section. The section will automatically block and hold when it is up. • To fold back: make sure the upper body section is up. Pull out the lock pin of the sitting section and at the same time fold down the section. <div style="border: 1px solid black; padding: 5px; text-align: center;">  WARNING  </div> <ul style="list-style-type: none"> • Please watch your surroundings when operating the locking pin. Make sure nobody will operate the actuator for the upper body section.
<p>Long knee support</p> 		<p>The radial clamp is necessary in order to use this accessories. These rail clamps fit on the rail that is mounted standard on the table.</p> <ul style="list-style-type: none"> • To mount the clamp to the rail: hook it in a downward movement. Now tighten the clamp with the lower lever. • To fix the knee support: Put the support in the clamp and tighten the clamp with the lever in the middle. • To adjust the angle of the knee support: Loosen the lever in the middle and adjust the angle. When the support is placed in the right position, tighten the clamp again with the same lever.
<p>Adjustable neck cushion</p> 		<p>The cushion can be placed anywhere on the backrest with a Velcro strap</p>
<p>Set of short knee supports</p> 		<p>With the help of these supports one can create an ideal position for various leg plasters and all kind of bandage techniques. It also helps to make several plaster techniques of the leg easier.</p> <ul style="list-style-type: none"> • These supports can easily be plugged in under the upper- or the lower leg-rests. In total there are three positions to plug the supports in. • After use the supports can be stowed away at the back side of the monkey pole.

<p>Paperrollholder</p> 		<p>The paperrollholder is fitted to the monkey pole at the back of the table. Therefore the paper will move up and down along with the table and the patient. The maximum width of the paper that one can fit on this holder is 60cm.</p> <ul style="list-style-type: none"> • To put on a roll of paper: remove the black round knob at the end of the holder. • Pull out the stainless steel axle from the holder. • Put the roll of paper between the holders. Now push the stainless steel axle through the holder and the paper. • Now crew the black round knob back on.
<p>Small castors (standard)</p> 	<p>Big castors</p> 	<p>The table is standard mounted with four wheels with a diameter of 75mm. As an option one can choose for bigger castors with a diameter of 125mm. Please notice that this will have a small effect on the lowest and the highest position. The braking system will not change in any way.</p>
<p>Set of crutch holders</p> 		<p>As an option 2 clamps for crutches can be mounted at the back side of the monkey pole. During the treatment the crutches can be stowed and can be taken off easily when needed again.</p>

4. CLEANING and CONSERVATION

For durable joy with the Skai® material, please clean regularly. For cleaning use a cloth or soft brush dampened using water and a neutral detergent. Any stains on the upholstery should be promptly removed with colourless ethyl alcohol diluted in 20% water. Rinse well.

 **WARNING** 

- ENSURE THE COUCH IS PERFECTLY CLEAN BY DISINFECTING THE SYNTHETIC LEATHER AND APPLYING A SINGLE-USE PAPER SHEET AT EVERY USE.
- HARSH DETERGENT PRODUCTS MAY DAMAGE THE SURFACES.
- DO NOT USE STEAM JETS, WASHING TUNNELS, WATER JET CLEANERS OR HIGH PRESSURE WASHERS

5. MAINTENANCE

Maintenance operations must be carried out by technicians who are familiar with the contents of this instruction booklet. Check the equipment is safe after any instances of "rough handling" (e.g. fall, bumps, etc.) and any time you are in doubt about safety.



ROUTINE MAINTENANCE

Routine maintenance operations must be carried out with the frequency indicated in the table.

FREQUENCY	ACTIVITY
Every 6 months or at least once a year	General equipment cleaning.
	Visual and functional inspection of the equipment and related hydraulic and manual controls.
	Frame and mechanical parts: Check screws and bolts are tight; state of wear of bushings and pins, presence of tears and deformations or damages.
	Oil leaks from the piston and/or gas springs must only be in the form of minor lubrication residue.
	Check that the adjustable sections are stable and do not give way when the control lever is released.
	Brake control: check regular functioning of the activating device and the efficiency of the brakes.
	Wheels: these must be securely fixed and in good condition, rolling smoothly and with their treads free of impediments.
During use and operation, make sure there are no unusual sounds, vibrations or oscillations that may indicate actuator and/or mechanism malfunctions.	
At the end of the activities above, complete the inspection performing a lift cycle with the stated maximum safe load.	

NON-ROUTINE MAINTENANCE

For safety reasons and to avoid invalidating the guarantee, no component may be opened or handled for repair. Any faults on the hydraulic piston, the gas springs and the wheel system must be diagnosed by Wesseling BV, who will organize the most suitable action.

 **WARNING** 

- IF SAFETY SEEMS TO BE AT RISK, DISABLE THE EQUIPMENT IMMEDIATELY PREVENTING ANY POSSIBILITY OF USE UNTIL SUCH RISK HAS BEEN REMOVED.
- PLEASE RECORD ANY DEFECTS/DAMAGES/SERVICES THAT ARE IMPORTANT FOR THE SAFETY OF THE EQUIPMENT IN THE APPROPRIATE FORM HEREWITH ENCLOSED.

SPARE PARTS

Only use original spare parts from Wesseling. Please contact Wesseling BV for the parts you might need.

6. TROUBLESHOOTING

DIRECT E-MAIL FOR TECHNICAL OR USERS ASSISTANCE:

info@wesseling-bv.com

If you rather want to speak to one of us on the phone you can call: +31-20 497 5183



Please note:

- Before contacting for service or help, please identify the "SERIAL NUMBER" in the product label attached to the equipment (see example above), or the transport document/invoice number. This will speed things up and improve service quality.

The equipment was tested in very stringent conditions. during testing no specific breakages or faults occurred.

If the equipment fails to operate, please follow the troubleshooting process below.

Issue	Cause	Solution
Adjustment of the leg-sections does not work or the position is not maintained	Gas spring faulty or incorrectly set	Contact Wesseling BV
	Transmission cable damaged or broken	
One of the actuators does not work	One of the footswitches is broken	Contact Wesseling BV
	Power cable is damaged or not connected in a proper way	
	Actuator is damaged or not connected in a proper way	

7. TECHNICAL DATA SHEET

Product Name	New Plaster Master
Product Code	PLASTMAST00
Safe working load	200kg
Max patient weight	175kg
Electric adjustable sections	3
Height adjustment: complete table	Small castors: 61 to 111cm with a speed of 11mm/s - 10.000N, 850W, 3.6Ah, stroke 200mm Big castors: 65 to 115cm with a speed of 11mm/s
Height adjustment: upper body section	0 to 30cm with a speed of 10mm/s - 8000N, 470W, 2.0Ah, stroke 200mm
Adjustment electric backrest	0° to 90° with a speed of 14mm/s - 2000N, 350W, 1.5Ah, stroke 200mm
Adjustment system	German electric actuators
Adjusting electrics	Triple footswitch from Stainless Steel
Sections adjusted by gas spring	4
Upper leg sections	0° to 65°
Lower leg sections	+45° to -90°
Adjusting gas spring	By levers that are on both sides of the table
Wheels	Ø75mm or Ø125mm (optional)
Braking system	Centralized control on the back of the table
Equipment weight	± 150kg
Length	212cm with legsections horizontal / 165 cm with legsections vertical
Width	64cm
Height	207cm – 255cm (total height with monkey pole)
Upholstery thickness	± 55mm
Filling	Polyether SG 90/30 / sitting section has an extra filling with Lazyfoam for extra comfort
Semi Leather	Original SKAI® or STAMSKIN

8. WARRANT

GENERAL AFTER-SALES SERVICE CONDITIONS FOR WESSELING ITEMS

